

The Open Group

Exam OG0-021

ArchiMate 2 Part 1 Examination

Version: 6.0

[Total Questions: 80]

Topic break down

Topic	No. of Questions
Topic 1: Volume A	40
Topic 2: Volume B	40

Topic 1, Volume A

Question No : 1 - (Topic 1)

Consider the following diagram:

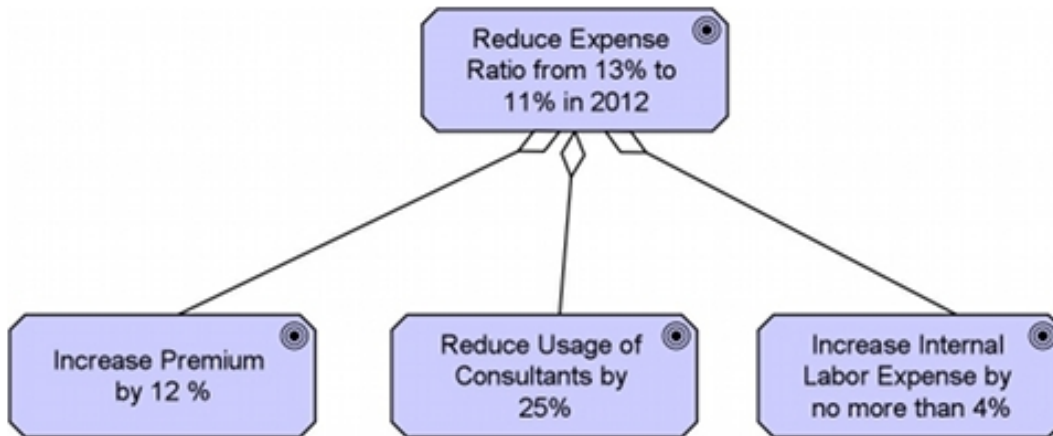

Which answer most accurately interprets what the diagram indicates about the goal "Reduce Expense Ratio from 13% to 11% in 2012"?

- A. The goal is decomposed into three other goals
- B. The goal is similar to the three other goals
- C. The goal must be achieved before any of the other three goals is achieved
- D. The goal will be achieved if at least one of the other three goals is achieved in 2012

Answer: A

Question No : 2 - (Topic 1)

Consider the following diagram, which shows a relationship between two business objects:

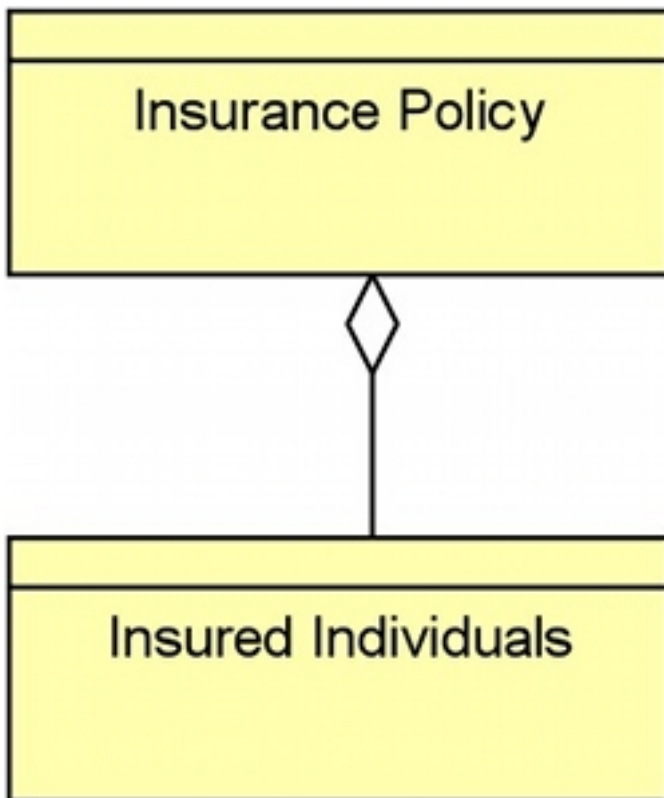

Which of the following best describes the relationship shown in the diagram between Insurance Policy and Insured Individuals?

- A. Insurance policy is composed of insured individuals
- B. Insurance policy is used by insured individuals
- C. All required information about insured individuals is stored within the insurance policy record
- D. Insurance policy groups insured individuals

Answer: D

Question No : 3 - (Topic 1)

Consider the following diagram, in which CSR stands for Customer Service Representative:

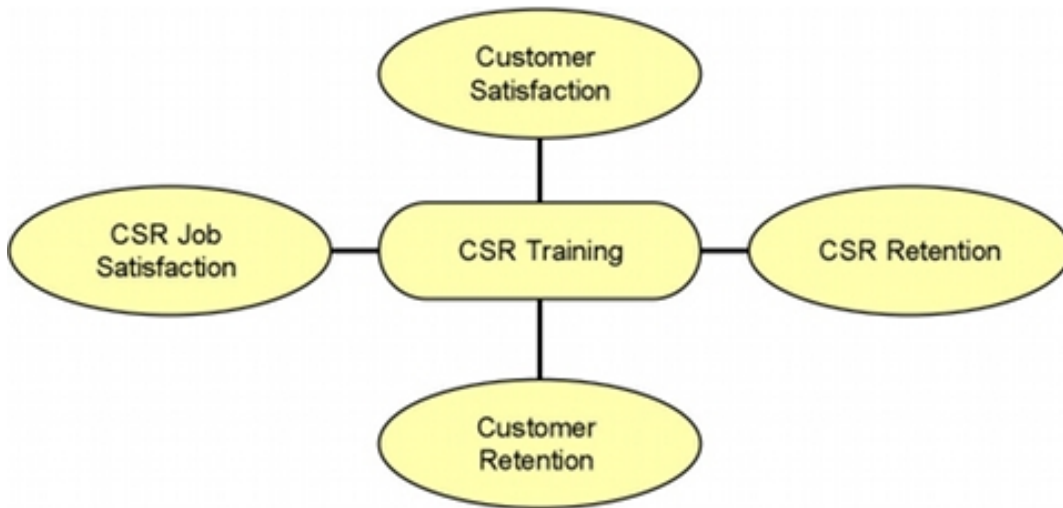

Which of the following statements is expressed by the diagram?

- A. CSR Training has four key modules, each focusing on a different topic
- B. The CSR Training business service is valuable in four different ways
- C. CSR Training is a basic service, upon which four sub-services depend
- D. CSR Training accesses four different types of information

Answer: B

Question No : 4 - (Topic 1)

Maya has been working for ArchiSurance for five years. The following diagram describes her responsibilities:

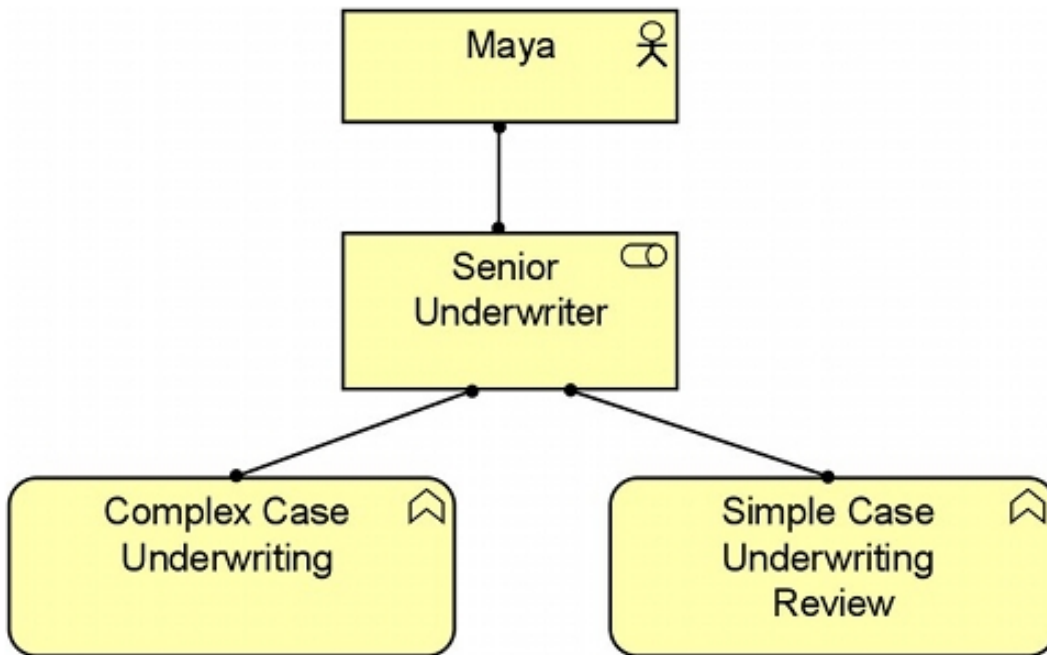

Which of the following answers best interprets the diagram?

- A. Maya works with the Senior Underwriter who works directly on complex cases and reviews simple cases
- B. Maya supervises a Senior Underwriter who works directly on complex cases and reviews simple cases
- C. In her Senior Underwriter role, Maya supervises separate teams that work directly on complex cases and review simple ones
- D. In her Senior Underwriter role, Maya works directly on complex cases and reviews simple cases

Answer: D

Question No : 5 - (Topic 1)

Consider the following diagram using the Implementation and Migration extension:

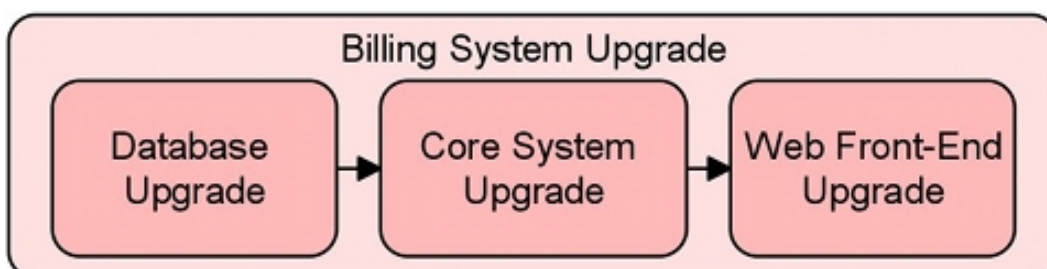

Which of the following statements correctly describes the concepts shown in the diagram?

- A. Business processes
- B. Plateau and deliverables
- C. Project components
- D. Work packages

Answer: D

Question No : 6 - (Topic 1)

Consider the following diagram representing part of a key PRO-FIT capability: self-service online price quotes for its auto insurance customers:

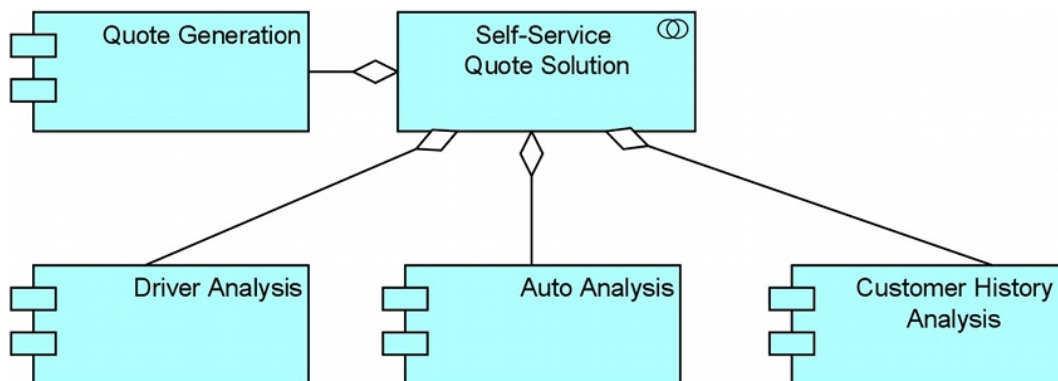

Which of the following answers best interprets this diagram?

- A. The Self-Service Quote Solution is an application service that uses four separate application components
- B. The Self-Service Quote Solution is an application collaboration that includes four application components that work together
- C. The Self-Service Quote Solution is an application component that accesses four different types of data objects
- D. The Self-Service Quote Solution is an application component that collaborates with four service modules

Answer: B

Question No : 7 - (Topic 1)

Consider the following symbol, which represents information about a transformation project at ArchiSurance involving systems and business processes:



Which of the following statements correctly expresses the meaning of the symbol?

- A. The ArchiSurance legal department has determined the impact of the new regulations
- B. The project must satisfy requirements for additional reporting
- C. The additional reporting requirements in new insurance regulations are driving change at ArchiSurance
- D. The project's systems must be flexible enough to accommodate any future changes in reporting requirements

Answer: C

Question No : 8 - (Topic 1)

Which of the following best describes why ArchiMate supports specialization of concepts?

- A. It is the only way to model enterprise architectures that are useable and easy to communicate to the stakeholders
- B. It is needed to represent the same concept on different viewpoints
- C. It provides extra flexibility, enabling users to customize the language to their own preferences and needs, while maintaining the underlying precise definition of the concepts
- D. It is allowed because without this mechanism it would be impossible to add attributes to ArchiMate concepts and relations

Answer: C

Question No : 9 - (Topic 1)

Which application layer concept is defined as a passive element?

- A. Application component
- B. Application function r
- C. Data object
- D. Business object

Answer: C

Question No : 10 - (Topic 1)

The diagram below shows key elements of the configuration of ArchiSurance's newest and most powerful high-end server, which is a model T-9900:

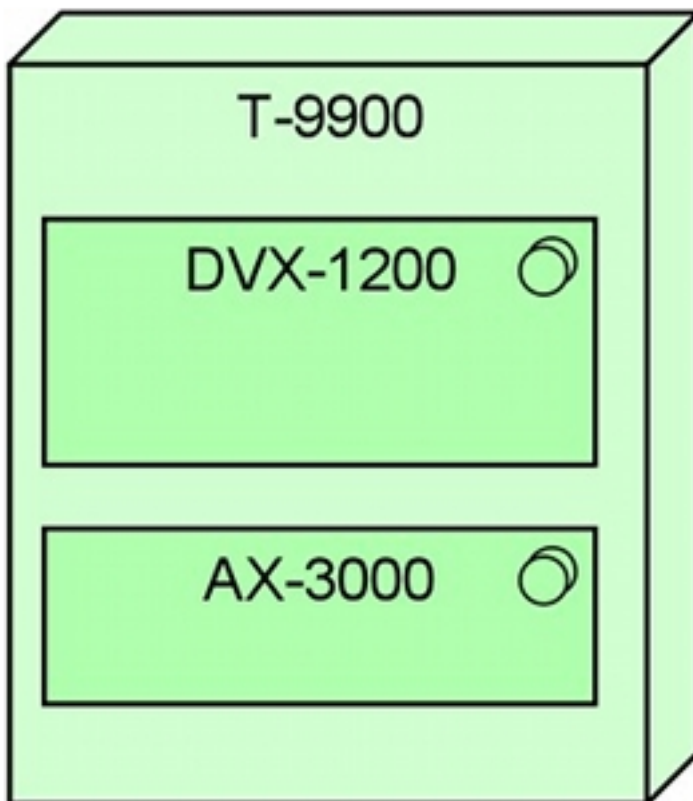

Which of the following descriptions of the configuration is most consistent with the diagram?

- A. The T-9900 is fitted with a DVX-1200 cooling system and and AX-3000 onboard disk

array

B. The T-9900 is running PRO-FIT's custom, internally-developed DVX-1200 software for enterprise risk analysis and is fitted with an AX-3000 onboard disk array

C. The T-9900 node is running DVX-1200 middleware and the AX-3000 operating system software

D. The T-9900 is an assembly of DVX-1200 processing units and AX-3000 high-speed memory arrays

Answer: C

Question No : 11 - (Topic 1)

Consider the following diagram:

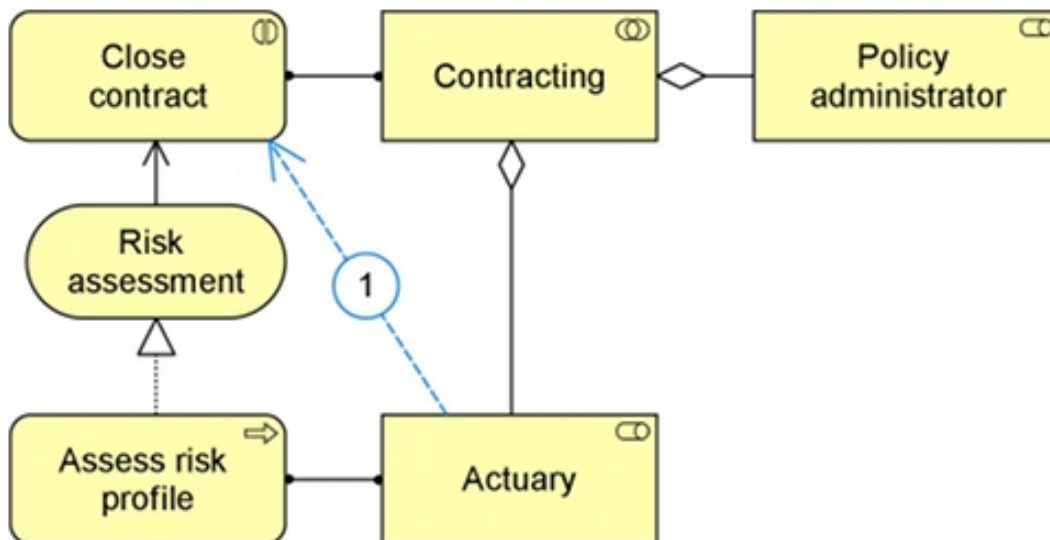

What is the strongest structural relationship that can be derived from business role Actuary to business interaction Close contract (indicated by number 1 in the diagram)?

- A. Assignment
- B. Aggregation
- C. Realization
- D. Used by

Answer: D

Question No : 12 - (Topic 1)